

Smart Tropfenzähler

Bestellnummer 119.4001

Im Lieferumfang enthalten

(a) Mikrorührstab	(d) Absperrhahn
(b) Smart Tropfenzähler	(e) Tropfenspitze
(c) Spritze (60 ml)	(f) Spritzenhalter

Micro USB Kabel (1 Meter)

Zusätzlich erforderlich: Software SPARKvue oder Capstone von PASCO



Schnellstart für Smartphones

Kostenlose App für Android und iOS



Zur iOS-App

Scannen Sie den QR-Code ein und Sie gelangen direkt zur kostenlosen App „SPARKvue“ in Ihrem AppStore. Sie installieren die App auf Ihrem Endgerät (Tablet / Smartphone mit iOS oder Android).



Zur Android-App

Für Windows PC und Mac finden Sie eine kostenpflichtige Variante unter >>><https://www.conatex.com/catalog/sku-1104020>.

Einschalten

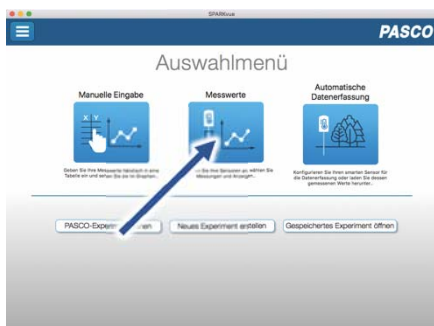

Sie schalten Ihren Sensor auf der Oberseite ein und starten die SPARKvue App. Auf dem Startbildschirm wählen Sie in der Mitte den Punkt „Messwerte“.

Verbinden



Sensorauswahl

Darstellung

Sie kommen zur Sensor-Konfiguration. In der linken Spalte wählen Sie Ihren Sensor aus. Danach können Sie rechts die Darstellung der Messwerte aussuchen.

Messen & Auswerten



Messung starten & beenden

Um eine Messung zu starten klicken Sie auf den grünen Knopf mittig unten in der Leiste. Die Messung beendet Sie in dem Sie wieder auf das nun rote Quadrat drücken.



Mit folgendem QR-Code gelangen Sie direkt zu unserer kostenlosen Video-Anleitung. Diese finden Sie in unserem Webshop auch bei der Lizenz von SPARKvue unter >>><http://www.conatex.com/q1104020>. Dort finden Sie auch Betriebsanleitungen zum kostenlosen Download.

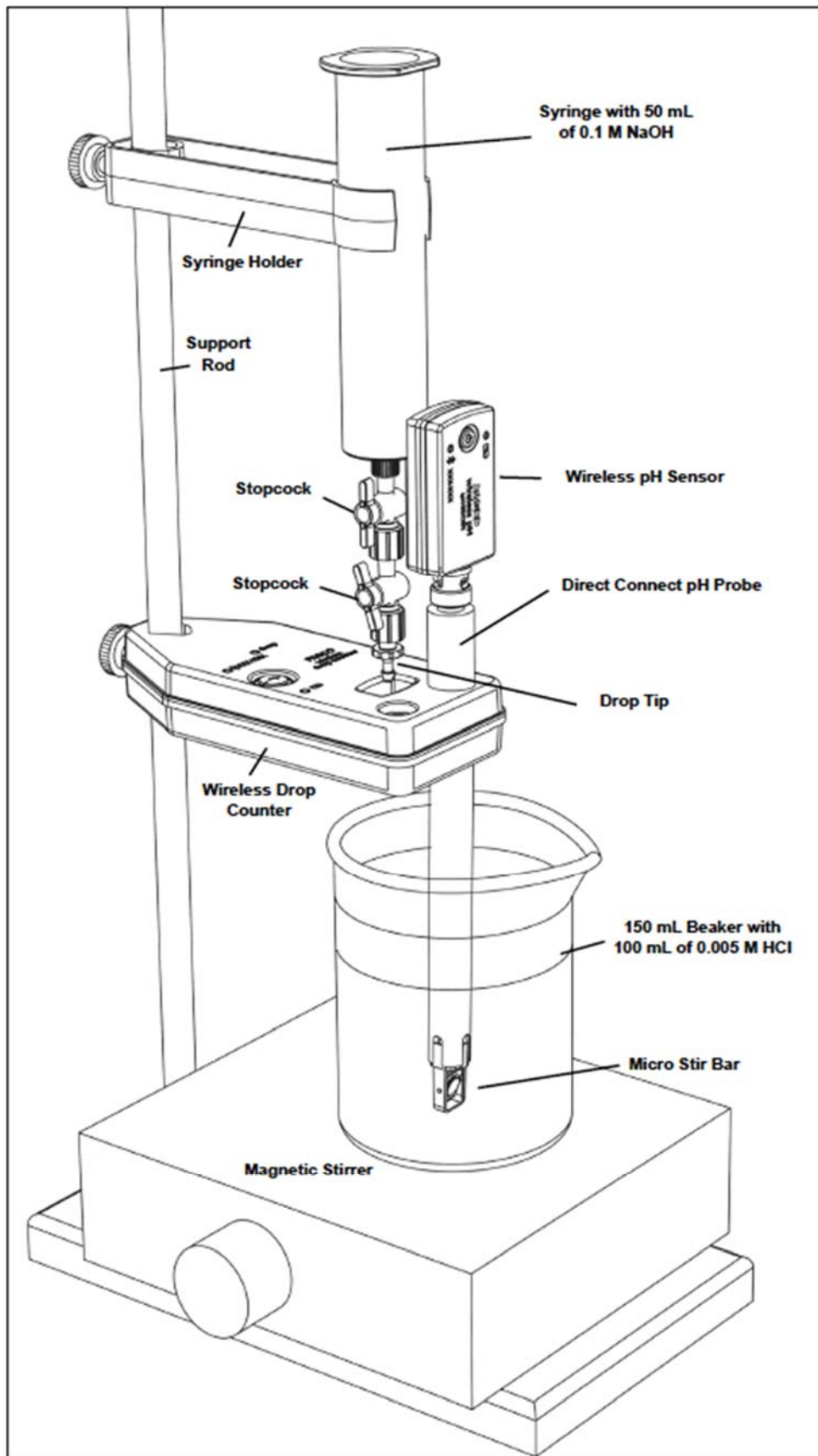

Zweck und bestimmungsgemäßer Gebrauch

Der Smart Tropfenzähler zählt Tropfen, die durch seine rechteckige Öffnung fallen und rechnet diese in Volumen um.

Ein LED auf der Oberseite blinkt bei jedem Zählereignis kurz auf. Er ist für Titrationsexperimente optimiert, lässt sich an einem Laborständer montieren und hat integrierte Halterungen für einen Temperatursensor und einen weiteren Sensor wie, pH-Wert, Leitfähigkeit, Redoxpotential...

Die mitgelieferten Teile lassen sich zu einem Tropfenspender zusammenbauen, der sich am gleichen Laborständer befestigen lässt.

Das Gehäuse des Tropfenzählers besteht aus Polypropylen, ist wasserfest und chemisch beständig gegen milde Säuren und Laugen.

Der Sensor lässt sich drahtlos über Bluetooth oder über USB-Kabel (im Lieferumfang enthalten) an Smartphones, Tablets und Computer anschließen.

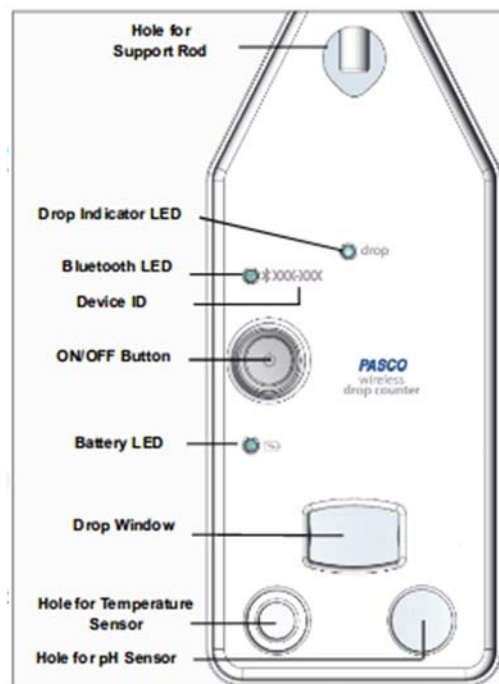

Handhabung

Der mitgelieferte Mikrorührstab lässt sich an das Ende einer pH- oder Leitfähigkeitssonde angeschlossen und mit einem Magnetrührer antreiben. Er sorgt für einen konstanten Lösungsfluss über das Ende der Elektrode.

Mit dem unteren Absperrhahn des Tropfenspender lässt sich die eingetropfte Menge regulieren, der obere Absperrhahn sollte immer ganz geöffnet oder ganz geschlossen sein.

Um die richtige Menge von Flüssigkeit pro Tropfen einzustellen, wählen Sie „Messung kalibrieren“ bei „Volumen der Flüssigkeit“ und dann die 1-Punkt Kalibrierung.

Der erste Punkt der folgenden Kalibrierung ist 0 ml bei 0 Tropfen. Um den zweiten Punkt festzulegen, tropfen Sie während des Kalibriervorgangs eine beliebige Menge in ein Gefäß, das Sie gut ablesen können. Während Sie das tun, wird die Anzahl der Tropfen im Feld „Sensorwert“ mitgezählt.

Der Button „vom Sensor ablesen“ ist in diesem Falle überflüssig.

Wenn Sie eine gute Ablesung Ihrer Füllmenge haben, tragen Sie diesen Wert in das Feld oberhalb der Tropfenzahl ein und bestätigen Sie mit „OK“.

Hinweise:

- Vermeiden Sie Berührungen mit der Vorrichtung, während die Messung läuft, weil diese die Tropfengröße ändern können.
- Halten Sie die Tropfgeschwindigkeit während einer Messung konstant, weil sich Änderungen auf die Tropfengröße auswirken.
- Die Tropfengröße ist extrem abhängig von der Stellung der Absperrhähne und von der Viskosität der jeweiligen Flüssigkeit. Es ist empfehlenswert sie vor jeder Titration neu zu kalibrieren.

Verbinden

Klicken Sie auf das Feld „Messwerte“. Es erscheint eine Übersicht zur „Sensordaten-konfiguration“. Hier sehen Sie links die Sensoren, die schon verbunden sind, und die, die Sie noch verbinden können. Der oberste Sensor in der zweiten Liste liegt normalerweise am nächsten zu Ihrem Endgerät. Zum Abgleichen hat jeder Sensor eine Geräte-ID, damit Sie diese mit der angezeigten ID vergleichen können.

Kalibrierung

Bei Verwendung der pH-Sonde und der ORP-Sonde ist eine Kalibrierung möglich, jedoch selten erforderlich.

Ionen-selektive Sonden hingegen verlangen besondere Sorgfalt und benötigen wegen ihres Messverfahrens vor jeder Anwendung eine Kalibrierung. ISE-Sonden eignen sich nur für fortgeschrittene Anwender.

Messen

Um eine Messung zu starten müssen Sie jetzt nur noch in der rechten Spalte eine Vorlage auswählen oder direkt in ein Schnellstart-Experiment springen. Wenn Sie danach unten auf den grünen Start-Knopf klicken erfassen Sie schon Messwerte.

Data-Logger

Der Menüpunkt „Automatische Messwernerfassung“ führt zunächst zu einer Liste aller erreichbarer Sensoren, sortiert nach Entfernung und danach, ob sie Messwerte gespeichert haben. Im folgenden Dialog wird die Abtastrate eingestellt und nach Abschluss mit „OK“ der Sensor in Bereitschaft versetzt. Die Bluetooth-LED blinkt gleichmäßig gelb. Nachdem Sie Ihren Sensor in die gewünschte Position gebracht haben, starten Sie die Automatik durch eine kurze Betätigung des Einschaltknopfes. Der Rhythmus der Bluetooth-LED wechselt nach Gelb-Rot -Pause. Die automatische Messung endet mit dem Ausschalten des Sensors und durch die erneute Verbindung mit der Software.

Eine Video-Anleitung dazu finden Sie unter >><https://www.youtube.com/watch?v=1lin5ToaxK0>. Die Daten können Sie auf dem gleichen Weg von Sensor herunterladen, indem Sie statt diesen vorzubereiten einfach im Bereich „Sensor mit Messwerten“ auswählen und die Daten herunterladen und sich anzeigen lassen.



LED-Informationen

Die Leuchtanzeigen für Bluetooth und den Batteriestatus haben folgende Bedeutungen:

Bluetooth-LED	Status
Rot blinkend	Bereit
Grün blinkend	Verbunden
Gelb blinkend	Erfassung läuft Oder Automatik bereit
Gelb-Rot funkelnd	Automat. Erfassung läuft
AUS	Datenerfassung über USB

Akkuanzeige	Status
Rot blinkend	Schwache Akkuladung
Gelb dauernd	Aufladen
Grün dauernd	Vollständig geladen

Entweder überträgt der Sensor laufend Messwerte an ein gekoppeltes Gerät oder er speichert sie intern. Gespeicherte Messreihen können bei der nächsten Verbindung mit PASCO Software ausgelesen werden. Die unabhängige Messwernerfassung empfiehlt sich besonders für Langzeitexperimente.

Technische Spezifikationen

Maximale Zählrate	6 Tropfen pro Sekunde
Minimale Tropfengröße	0,64 mm
Detektor	Parallelisiertes Infrarot, unempfindlich auf Fremdlicht
Maximale Abtastrate	10 Hz

Fehlerbehebung

Versuchen Sie eine abgerissene Bluetooth-Verbindung wiederherzustellen, indem Sie die EIN/AUS-Taste des Sensors gedrückt halten, bis die Status-LEDs nacheinander blinken. Schalten Sie danach den Sensor normal ein. Wenn der Sensor keine Verbindung mehr mit der Software hat, starten Sie bitte zuerst die Software neu. Danach erst verfahren Sie nach dem oben beschriebenen Weg. Versuchen Sie Bluetooth bei Ihrem Endgerät aus und wieder einzuschalten.

Lagerung und Pflege

Lagern Sie den Sensor an einem kühlen, trockenen Ort. Schützen Sie die den Sensor vor Staub, Feuchtigkeit und Dämpfen. Reinigen Sie das Gerät mit einem leicht feuchten, fusselfreien Tuch. Scharfe Reinigungsmittel oder Lösungsmittel sind ungeeignet.

Sicherheitshinweise

- Vor Inbetriebnahme des Gerätes ist die Bedienungsanleitung sorgfältig und vollständig zu lesen. Sie schützen sich und vermeiden Schäden an Ihrem Gerät.
- Verwenden Sie das Gerät nur für den vorgesehenen Zweck.
- Das Gerät nicht öffnen.

Entsorgungshinweise

Elektro-Altgeräte Entsorgung



Es obliegt Ihrer Verantwortung, Ihr elektronisches Gerät gemäß den örtlichen Umweltgesetzen und -vorschriften zu recyceln, um sicherzustellen, dass es auf eine Weise recycelt wird, die die menschliche Gesundheit und die Umwelt schützt. Um zu erfahren, wo Sie Ihre Altgeräte zum Recycling abgeben können, wenden Sie sich bitte an Ihren örtlichen Abfallentsorgungsdienst oder an den Ort, an dem Sie das Produkt gekauft haben. Das WEEE-Symbol der Europäischen Union und auf dem Produkt oder seiner Verpackung weist darauf hin, dass dieses Produkt NICHT mit dem normalen Hausmüll entsorgt werden darf.

Batterie Entsorgung



Batterien enthalten Chemikalien, die, wenn sie freigesetzt werden, die Umwelt und die menschliche Gesundheit beeinträchtigen können. Batterien sollten für das Recycling getrennt gesammelt und an einer örtlichen Entsorgungsstelle für gefährliche Stoffe unter Einhaltung der Vorschriften Ihres Landes und der örtlichen Behörden wiederverwertet werden. Um herauszufinden, wo Sie Ihre Altbatterie zum Recycling abgeben können, wenden Sie sich bitte an Ihren örtlichen Abfallentsorgungsdienst oder an den Produktvertreter. Die in diesem Produkt verwendete Batterie ist mit den internationalen Symbolen gekennzeichnet, um die Notwendigkeit der getrennten Sammlung und des Recyclings von Batterien anzuzeigen.

Technische Unterstützung

Für weitere technische Unterstützung wenden Sie sich an:

CONATEX DIDACTIC Lehrmittel GmbH
Zinzinger Straße 11
66117 Saarbrücken - Deutschland

Hotline Digital-Team: +49 (0)6849 – 99 296-54
Kundenservice (kostenfrei): 00800 0266 2839 oder +49 (0) 6849 – 99 296-0

Internet: <https://www.conatex.com>
Email: digital-team@conatex.com

Wireless Colorimeter and Turbidity Sensor

PS-3215

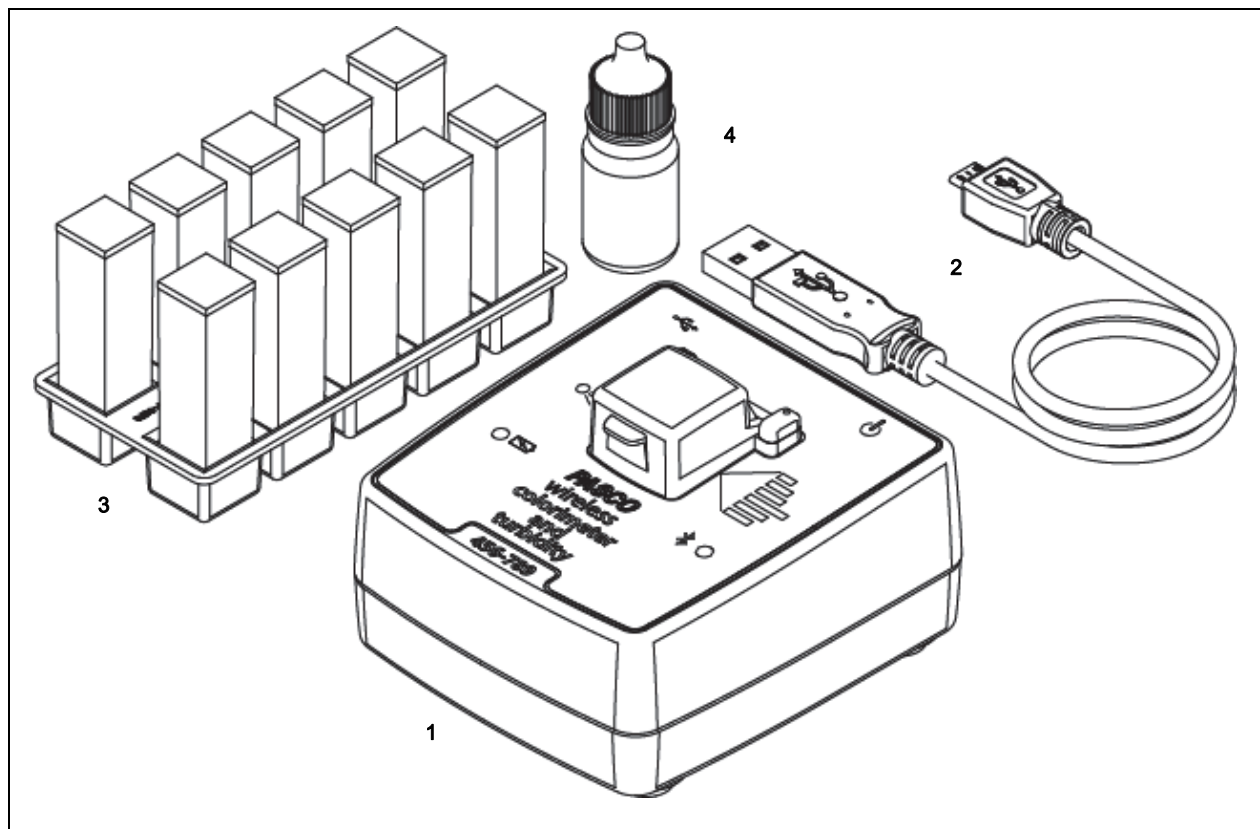

Included Equipment	Item	Included Equipment	Item
Wireless Colorimeter and Turbidity Sensor	1	USB-to-Micro-USB Cable	2
Cuvettes and Cuvette Holder	3	100 NTU Calibration Solution Bottle	4
Calibration Cuvette Label (not shown)			

Introduction

This Wireless Colorimeter and Turbidity Sensor is a versatile instrument that measures absorbance and transmittance of six color wavelengths through solutions using a sensing element that detects six wavelengths. The sensor makes twelve measurements: absorbance and transmittance of red, orange, yellow, green, blue and violet light. These measure-

ments can be used to determine a solution's concentration. These measurements can be used to approximate a solution's visible light spectrum, determine its concentration and observe a reaction.

The sensor can also measure the turbidity level (cloudiness) of water samples in nephelometric turbidity units (NTU) by measuring light scattered by the sample at 90 degrees. The light source is stabilized to prevent drift.

The Turbidity Sensor makes relative measurements of turbid solutions with a particle size between 0 and 200 microns. Because turbidity is a time-dependent dynamics phenomenon, factors such as particle density, particle size, temperature, and pressure may cause reading variation, especially in repeatability studies.

The sensor's opaque housing eliminates ambient light.

NOTE: The Wireless Colorimeter and Turbidity Sensor is designed for educational use only and is not recom-

mended for environmental compliance testing or similar activities.

The sensor can connect wirelessly via Bluetooth to a computing device such as a tablet or computer using PASCO data collection software (see www.pasco.com). The software supports data logging when the instrument is not connected to a computing device. The Wireless Colorimeter and Turbidity Sensor has a rechargeable battery pack.

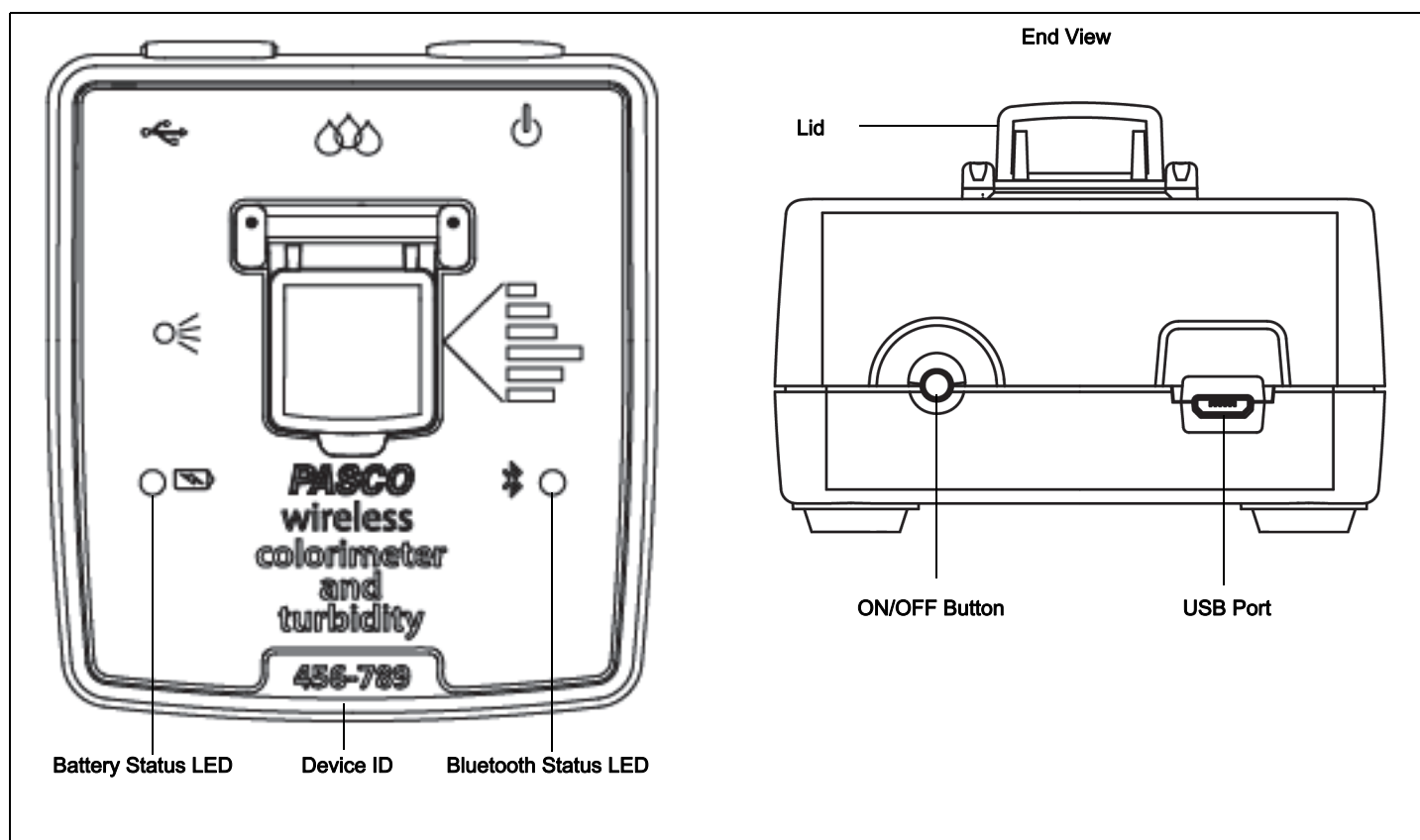

Operation

Charge the Battery

- **Connect the USB Cable:** Use the Micro USB Cable to connect the micro USB port on the back of the Wireless Colorimeter Sensor to a USB port on a USB charger (or a computing device).
- Charging begins automatically. The battery status LED shines yellow while the unit is charging, and will shine green when the battery is charged. The charger circuit inside the sensor turns itself off when the unit is fully charged. The battery is partially charged at the factory. Initial charging time may be three hours or longer.

Turn on the Sensor

Press the ON/OFF button. Both status LEDs will shine momentarily. If the battery is charged, the Battery status LED will stop shining. The Bluetooth status LED will continue to blink red. This indicates that the device is ready to connect wirelessly via Bluetooth to a computing device such as a computer or tablet.

To turn off the sensor, press and HOLD the ON/OFF button until the Battery status LED shines red momentarily.

Software Help

NOTE: See the SPARKvue Help or PASCO Capstone Help for information about collecting, displaying, and analyzing data.

- In SPARKvue, select the HELP button in any screen including the Home Screen.
- In PASCO Capstone, select PASCO Capstone Help from the Help menu, or press F1.

Connect the Sensor Wirelessly

Start the PASCO data collection software (such as PASCO Capstone or SPARKvue).

PASCO Capstone: Select “Hardware Setup” in the Tools palette. When the software detects the Wireless Colorimeter Sensor with Turbidity, the Bluetooth status LED on the sensor blinks green. In the Hardware Setup window, select the sensor that has a six-digit Device ID that matches the Device ID on the sensor itself. After searching, the software will display “Colorimeter” in Hardware Setup.

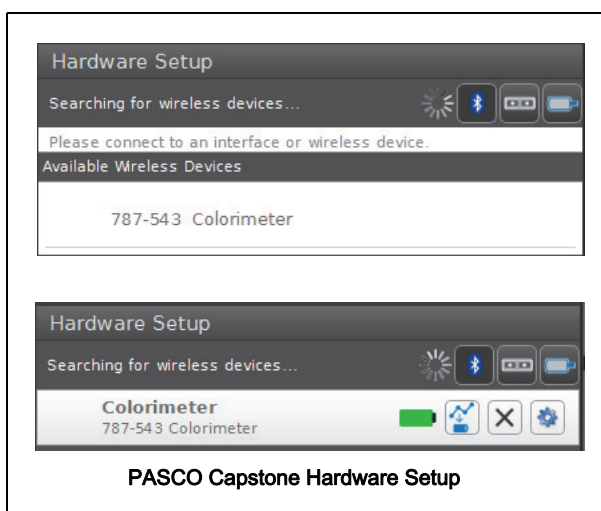

PASCO Capstone Hardware Setup

Select “Hardware Setup” again to close the Hardware Setup window.

in “Page #1”, drag a display or pick a QuickStart template in the main window.

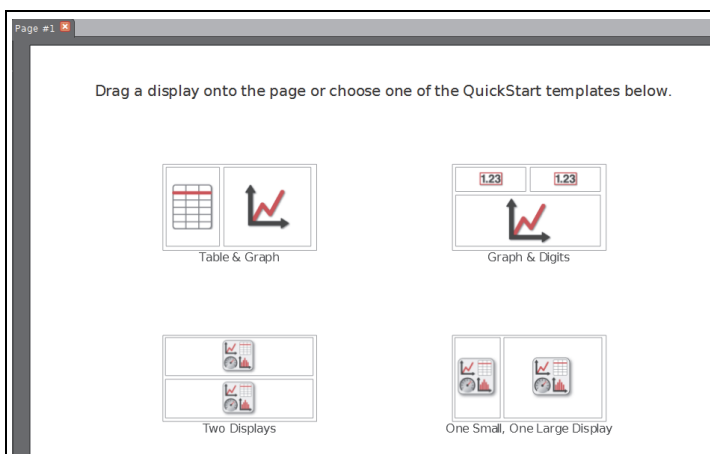

In the display, open a “Select Measurement” drop down menu. The menu shows the measurements that are possible with the sensor.

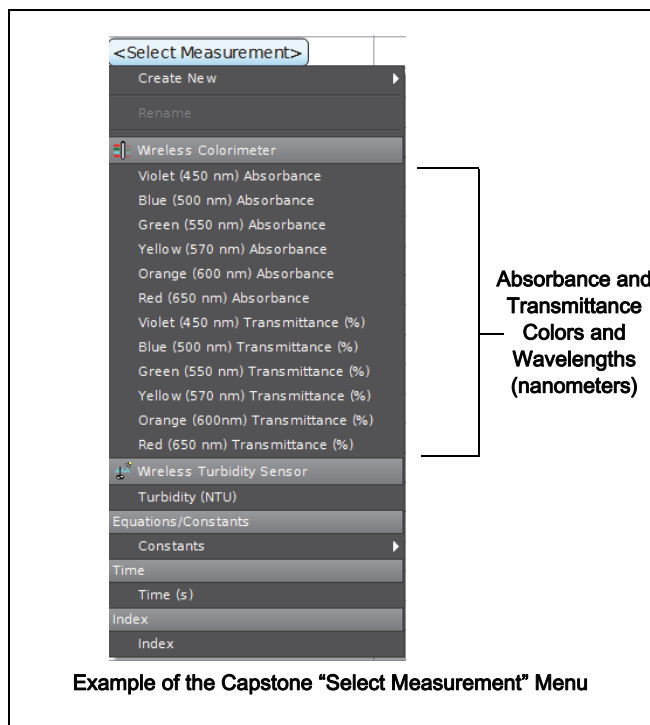

Example of the Capstone “Select Measurement” Menu

Make a choice from the drop down menu. The display will show the selected measurement versus time. Configure the display as needed.

SPARKvue: In the Home screen, select the “Bluetooth” icon at the top of the screen.

- The Wireless Devices window opens.

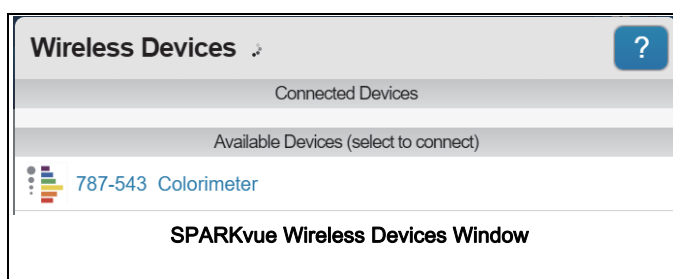

SPARKvue Wireless Devices Window

Select the “Available Device” that has the same six-digit Device ID as the one on the sensor. Select “Done” at the bottom of the window.

The SPARKvue Sensors window opens with a list of all the available measurements possible with the sensor.

Sensors		
Wireless Colorimeter ☑		
Violet (450 nm) Absorbance	0.000	⌵
Blue (500 nm) Absorbance	0.155	⌵
Green (550 nm) Absorbance	0.000	⌵
Yellow (570 nm) Absorbance	0.000	⌵
Orange (600 nm) Absorbance	0.060	⌵
Red (650 nm) Absorbance	0.354	⌵
Violet (450 nm) Transmittance	173.7 %	⌵
Blue (500 nm) Transmittance	69.9 %	⌵
Green (550 nm) Transmittance	103.5 %	⌵
Yellow (570 nm) Transmittance	107.3 %	⌵
Orange (600nm) Transmittance	87.4 %	⌵
Red (650 nm) Transmittance	44.4 %	⌵
Wireless Turbidity Sensor ☑		
Turbidity	102.2 NTU	⌵

SPARKvue Sensors Window Measurement List

Select a measurement to automatically open a Graph display or select a QuickStart template.

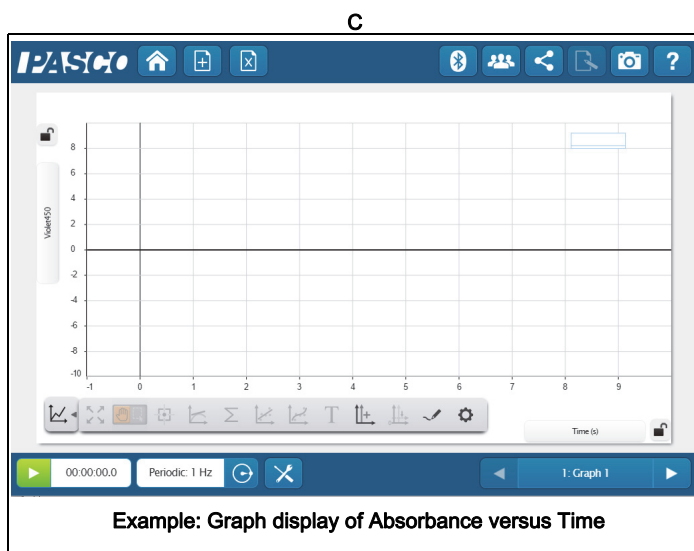

Calibration Preparation Procedure

Calibration is recommended before each experiment for better accuracy. Calibration is stored in the sensor. See Appendix A for an explanation of calibration procedures for colorimetry.

However, calibration is required the first time that turbidity is measured. It is also necessary when you are measuring solutions with varying temperatures, or when using different cuvettes. All calibrations are stored inside the sensor in flash memory.

Prepare a Turbidity Calibration Cuvette

The first part of the procedure is to make a “Calibration Cuvette”. This requires the 100 NTU Calibration Solution Bottle, one of the four-sided cuvettes, and the 100 NTU label with the expiration date.

Remove the lid from the four-sided cuvette. Carefully remove the cap of the Calibration Solution Bottle. Invert the bottle and hold the tip over the open cuvette. Squeeze the bottle to fill the cuvette approximately three-fourths full as shown below. Recap the bottle. Put the lid on the cuvette.

Put the 100 NTU label over the cuvette lid as shown.

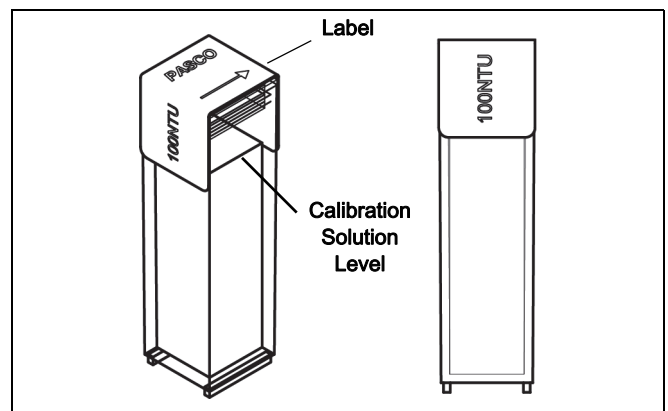

The direction arrow on the label indicates which way the calibration cuvette should be placed in the sensor. When placing the cuvette into the cuvette holder, make sure that the arrow points at the screw at the front edge of the holder.

Prepare a “Zero Standard” Cuvette

Fill another four-sided cuvette with deionized water to the same level as the solution in the calibration cuvette. This second cuvette will be used as the “zero” standard in a “two-point” calibration process.

Open the lid, put the cuvette with the deionized water into the cuvette holder, and close the lid.

Calibration

Follow the steps described in the PASCO data collection software to complete a “two-point” calibration for turbidity.

When calibration is complete, set up a Digits display, and start recording data. The Digits display should show approximately 100 NTU \pm 1 NTU.

Preparation for Intermittent Use

If the 100 NTU Calibration Cuvette is stored for more than a month, do the following before calibration.

1. Shake the cuvette vigorously for one minute to stir up the particles.
2. Allow the cuvette to stand undisturbed for five minutes to eliminate air bubbles.
3. Gently invert the cuvette five times.
4. Clean the outside of the cuvette.

Expiration

By following the preparation procedures, the 100 NTU Standard sample should provide accurate results (\pm 7%) up to the expiration data on the bottom of the Calibration Solution bottle. After the expiration date, PASCO cannot guarantee the stability of the sample.

Status LED Information

The Bluetooth and the Battery Status LEDs operate as follows depending on the type of connection:

For a connection to the USB Charger or a USB Port

Bluetooth	Status	Battery	Status
Red blink	Ready to pair	Yellow ON	Charging
Green blink	Connected	Green ON	Charged

For a wireless Bluetooth connection

Bluetooth	Status	Battery	Status
Red blink	Ready to pair	Red blink	Low power
Green blink	Connected		

Suggested Colorimetry Experiments

- Beer’s Law: find the relationship between the concentration and the absorbance of a solution. Use

this relationship to determine the concentration of an unknown sample.

- Reaction rate: measure changing absorbance over time as a chemical reaction occurs in the cuvette.
- Spectrum analysis: use the bar meter display to see a solution’s absorbance of all six colors. Compare different colored solutions.

Colorimetry Specifications

Range	0% to 100% transmittance 0 to 3 absorbance
Wavelengths (each with 40 nanometer FWHM)	450 nm (violet) 500nm (blue) 550 nm (green) 570 (yellow) 600 nm (orange) 650 nm (red)
Precision	\pm 0.03 absorbance units
Resolution	0.1% transmittance
Default sample rate	1 sample/s
Temperature range (for sensor and test sample)	5° C to 40° C (recommended)

Turbidity Specifications

Range	0 to 400 NTU*
Accuracy	5% for full range
Resolution	0.1 NTU
Temperature Range	5° C to 40° C

(*NTU = nephelometric turbidity units)

Battery Life

Battery Usage

Battery life is very important to making the sensor simple and always ready to use, so all of the PASCO wireless products are designed for long battery life. For example, the Wireless Colorimeter and Turbidity Sensor turns itself off after a brief time of inactivity to conserve battery life.

The battery life between charges for the Wireless Colorimeter Sensor ranges from one to four weeks or more.

If the battery status LED blinks red, connect the sensor to a USB Charger or to a USB port.

Maximizing Battery Life

One of the factors that affects battery life is the storage temperature. Therefore, avoid storing the Weather Source in very cold or very hot environments.

If the battery will not hold a charge, contact PASCO Technical Support.

Replacement Items

- Cuvettes and Caps (SE-8739) consists of 100 of the two-sided cuvettes and 100 cuvette lids.

Check with Technical Support regarding possible replacement items.

Technical Support

For assistance with any PASCO product, contact PASCO at:

Address: PASCO scientific
10101 Foothills Blvd.
Roseville, CA 95747-7100

Phone: 916-462-8384 (worldwide)
800-772-8700 (U.S.)

Email: techsupp@pasco.com

Web: www.pasco.com/support

Limited Warranty

For a description of the product warranty, see the PASCO web site.

Copyright

This PASCO scientific *Reference Guide* is copyrighted with all rights reserved. Permission is granted to non-profit educational institutions for reproduction of any part of this manual, providing the reproductions are used only in their laboratories and classrooms, and are not sold for profit. Reproduction under any other circumstances, without the written consent of PASCO scientific, is prohibited. Rev: 12/17

Trademarks

PASCO, PASCO scientific, PASCO Capstone, PASPORT and SPARKvue are trademarks or registered trademarks of PASCO scientific, in the United States and/or in other countries. All other brands, products, or service names are or may be trademarks or service marks of, and are used to identify, products or services of, their respective owners. For more information visit www.pasco.com/legal.

Product End of Life Disposal Instructions:

This electronic product is subject to disposal and recycling regulations that vary by country and region. It is your responsibility to recycle your electronic equipment per your local environmental laws and regulations to ensure that it will be recycled in a manner that protects human health and the environment. To find out where you can drop off your waste equipment for recycling, please contact your local waste recycle/disposal service, or the place where you purchased the product.

The European Union WEEE (Waste Electronic and Electrical Equipment) symbol (to the right) and on the product or its packaging indicates that this product must not be disposed of in a standard waste container.



Battery Disposal Instructions:

Batteries contain chemicals that, if released, may affect the environment and human health. Batteries should be collected separately for recycling, and recycled at a local hazardous material disposal location adhering to your country and local government regulations. To find out where you can drop off your waste battery for recycling, please contact your local waste disposal service, or the product representative.

The Lithium Polymer (Li-Poly) rechargeable battery used in this product is marked with the International recycling symbols to indicate the need for the separate collection and recycling of batteries.



Li-Poly

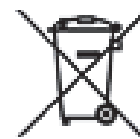

Appendix A

Theory of Calibration

One of the functions of the PASCO Data Collection Software is to take the stream of raw data from a sensor and transform it into the calibrated data that you see in the Graph, Table, and other displays. If you do not calibrate a sensor yourself, the software uses a default calibration that is loaded when the sensor is connected.

You can think of the software as taking in raw data and outputting calibrated data. When you perform a calibration, the software redefines the linear equation that transforms the raw input data into the calibrated output data. The linear function is of the form:

$$\text{Raw Input} = \text{Slope} \times \text{Calibrated Output} + \text{Offset}$$

Or:

$$\text{Calibrated Output} = (\text{Raw Input} - \text{Offset})/\text{Slope}$$

The function can be represented graphically as a line.

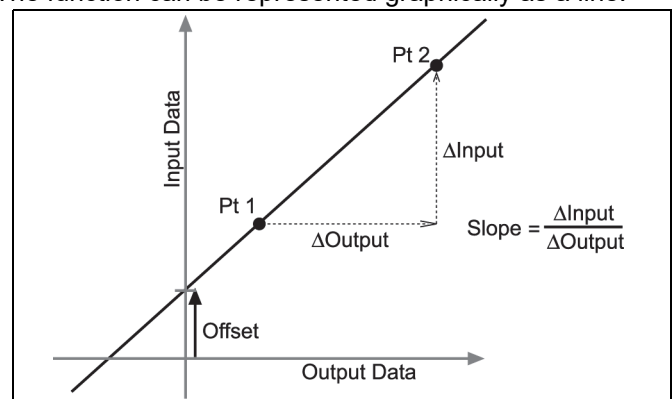

Two points, Pt 1 and Pt 2, define the line. In the two-point calibration procedure, each point is reset by associating a known standard value (for instance, the pH of a buffer solution) with a raw input measurement that the sensor sends to the GLX when it is in that standard. In a one-point calibration, only one of the points is reset by the user.

Types of Calibration

There are three types of calibration: two-point, one-point slope, and one-point offset. Any of these calibrations can be performed on a single sensor, or simultaneously on multiple similar sensors; however, for any given sensor, the software will automatically select the most typical calibration type as the default setting.

Two-Point

In a two-point calibration, you reset two points to define a new line. This type of calibration affects both the slope and the offset.

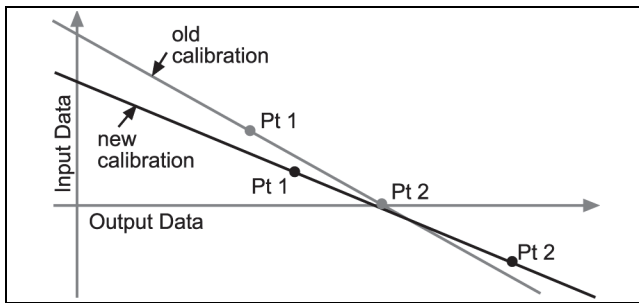

One-Point Slope

In a one-point slope calibration, you reset only one point. The slope of the line changes so that the line intersects the new point, while the offset (or Y-intercept) does not change.

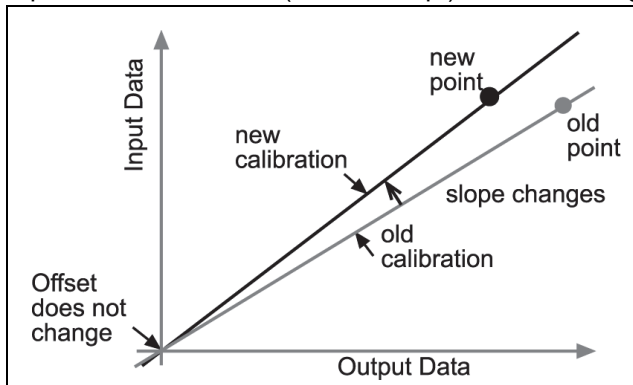

One-Point Offset

In a one-point offset calibration, you reset only one point. The line shifts so that it intersects the new point, but its slope does not change.

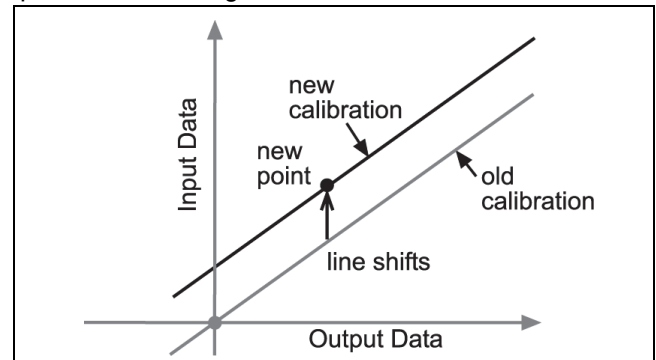

Offset calibration is usually used to make one sensor agree with another sensor. Due to normal variation among probes, a second probe might read consistently higher than the first probe. Normally this difference would be insignificant; however, an offset calibration can be used to bring the sensors into closer alignment.

Using PASCO Software for Calibration

NOTE: Check the on line Help System in SPARKvue or Capstone for the most up-to-date calibration information.

Oxidation Reduction Potential Probe

PS-3515

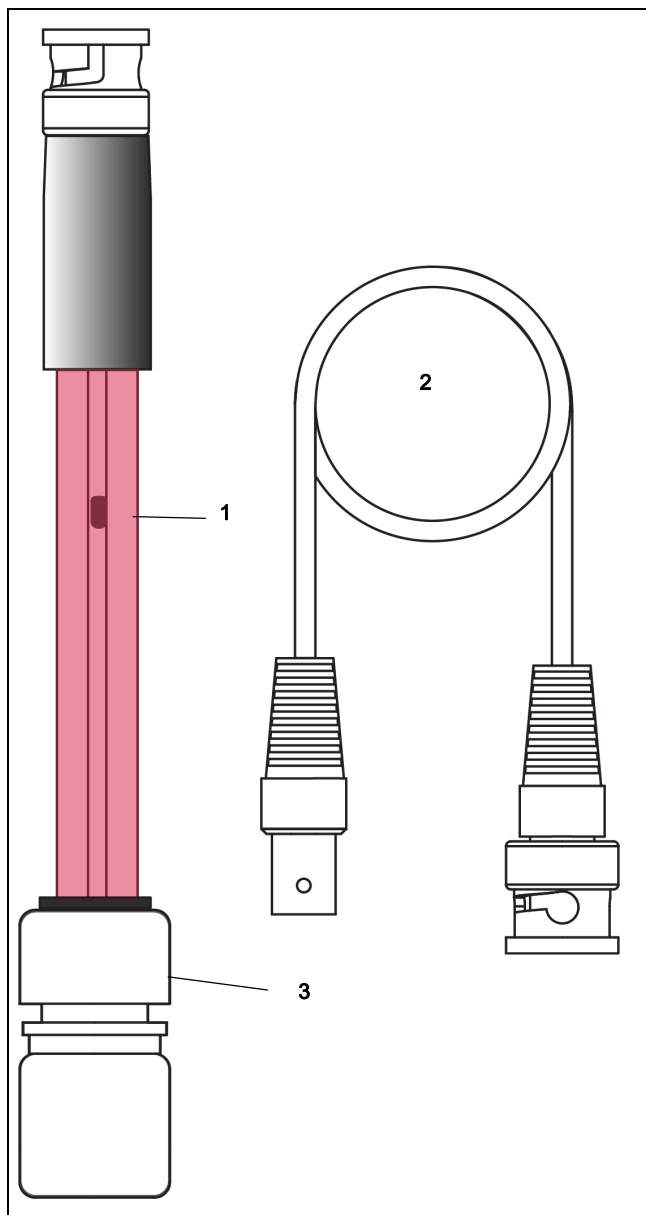

Introduction

This Oxidation Reduction Potential (ORP) electrode is a hand crafted, precision analytical device. Carefully follow the directions in this instruction sheet to obtain the best performance and electrode life.

Required Equipment and Solutions

- PASCO Wireless pH/ISE/ORP Sensor (PS-3204)

or

 - PASPORT High Precision pH/Temperature with ISE/ORP Amplifier (PS-2107) with a PASCO interface (see www.pasco.com for information)

or

 - pH/mV meter
 - PASCO data collection software (see www.pasco.com)
 - pH Buffer Solution 4.01* saturated with Quinhydrone (Solution has 2 to 4 use life after mixing)
 - pH Buffer Solution 7.00* saturated with Quinhydrone (Solution has 2 to 4 use life after mixing)
 - Wash bottle filled with distilled or de-ionized water
 - Laboratory magnetic stirrer and magnetic stir bar
 - Lab wipes
 - Laboratory Magnetic Stirrer with Stir Bar
 - Clean beakers**
- (*SC-2321 pH Buffer Capsule Kit)

Included Equipment	Item
Oxidation Reduction Potential Probe	1
Male-to-female BNC Cable	2
Storage Bottle	3

(**SE-7287 100 ml or SE-7288 1000 ml Beakers)

Preparation of the Electrode

1. Combination ORP electrodes are shipped with a storage bottle with storage solution. Keep the solution bottle and solution for future use.
2. Remove the storage bottle from the electrode and thoroughly rinse the electrode with distilled water. Wipe carefully with a clean lab wipe.

Software Help

See the SPARKvue Help or PASCO Capstone Help for information about collecting, displaying, and analyzing data.

- In SPARKvue, select the HELP button in any screen including the Home Screen.
- In PASCO Capstone, select PASCO Capstone Help from the Help menu, or press F1.

Checking Electrode Operation

1. Connect your ORP electrode to the input connector on the Wireless pH /ISE/ORP Sensor (or other pH measuring device). Ensure that the electrode connection is secure.
2. Place the electrode into a beaker containing quinhydrone saturated pH 7.00 buffer. Stir gently. The mV reading E1 should be 86 ± 20 mV.
3. Remove the electrode from the buffer. Rinse with distilled water and blot with a lab wipe.
4. Place the electrode into a beaker containing quinhydrone saturated pH 4.01 buffer. Stir gently. Record the mV reading E2. The difference between E2 and E1, (E2-E1), should be 175 ± 20 mV.

Reading a Sample with the Electrode

1. Rinse the electrode with distilled water and blot with a lab wipe. Place the electrode in a beaker containing the sample and a stir bar. Stir as before. Record the mV when the reading is stable.
2. Remove the electrode from the sample, rinse the electrode with distilled water over the "waste" beaker. Blot the electrode dry with a lab wipe. The electrode is now ready to read the ORP readings of other samples.

Storing the Electrode

Short Term

Between measurements, immerse the ORP electrode in the storage solution.

Long Term

When storing for long periods, store the ORP electrode in the storage bottle which came with the electrode.

Electrode Cleaning

Contamination of the sensing element often results in slow response and inaccurate readings. Clean the element by one of the following procedures:

1. Inorganic Deposits: Immerse electrode tip in 0.1 N HC1 for 10 minutes. Wash the tip with distilled water.
2. Organic Oil and Grease Films: Wash electrode tip in a liquid detergent and water.
3. After above treatment, soak the electrode tip in alcohol for 5 minutes and wipe dry, then, soak in quinhydrone saturated pH 4.01 for 15 minutes; rinse with distilled water afterwards.

NOTE: DO NOT ATTEMPT TO SAND OR POLISH THE SENSING ELEMENT WITH SAND PAPER OR OTHER POLISHING MATERIAL!

Technical Support

For assistance with any PASCO product, contact PASCO at:

Address: PASCO scientific
10101 Foothills Blvd.
Roseville, CA 95747-7100

Phone: 916-462-8384 (worldwide)
800-772-8700 (U.S)

Email: techsupp@pasco.com

Limited Warranty

For a description of the product warranty, see the PASCO catalog.

Copyright

This PASCO scientific instruction sheet is copyrighted with all rights reserved. Permission is granted to non-profit educational institutions for reproduction of any part of this manual, providing the reproductions are used only in their laboratories and classrooms, and are not sold for profit. Reproduction under any other circumstances, without the written consent of PASCO scientific, is prohibited. Rev: 10/17

Trademarks

PASCO, PASCO scientific, PASCO Capstone, PASPORT and SPARKvue are trademarks or registered trademarks of PASCO scientific, in the United States and/or in other countries. All other brands, products, or service names are or may be trademarks or service marks of, and are used to identify, products or services of, their respective owners. For more information visit www.pasco.com/legal.

Product End of Life Disposal Instructions:

This electronic product is subject to disposal and recycling regulations that vary by country and region. It is your responsibility to recycle your electronic equipment per your local environmental laws and regulations to ensure that it will be recycled in a manner that protects human health and the environment. To find out where you can drop off your waste equipment for recycling, please contact your local waste recycle/disposal service, or the place where you purchased the product.

The European Union WEEE (Waste Electronic and Electrical Equipment) symbol (to the right) and on the product or its packaging indicates that this product must not be disposed of in a standard waste container.

